

YOU CAN MAKE IT EVERYWHERE

ALPOLIC™ can be easily formed into any shape you want. It is exceptionally flat and our paint coating process guarantees the highest color quality.



ALPOLIC™

ALPOLIC™ is Aluminum Composite Material (ACM) for the worldwide construction industry. It is not only a reasonable alternative to solid aluminum sheets, but also a material distinguished by its unique features. Its light weight, high rigidity, excellent flatness and long-lasting coating qualities are just what the construction industry has been looking for.



Composition of ALPOLIC™

ALPOLIC™ and its affiliated products commonly have the following composition.

Total thickness: 3mm to 6mm

Surface finish (fluorocarbon or polyester coating, finished metal)

Metal skin (aluminum, titanium, stainless steel, zinc or copper)

Rust Preventing Paint

Core Material (fire retardant plastic or foamed plastic)

Backside finish (wash coating or metal)

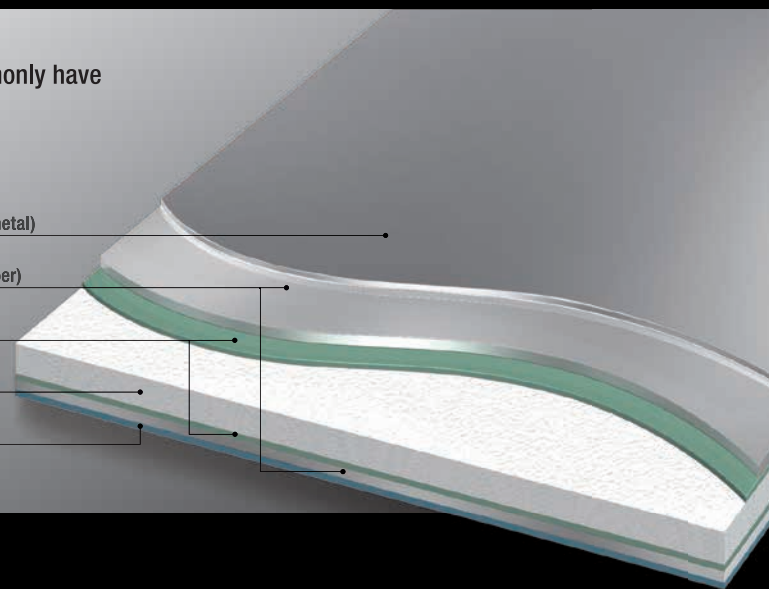

Feature of ALPOLIC™

FLATNESS:

Excellent flatness derived from the continuous laminating process



COLOR UNIFORMITY:

The coil coating process ensures complete color consistency



RIGIDITY:

ALPOLIC™ is rigid and lightweight



FIRE SAFETY:

With its non-combustible high mineral-filled core, ALPOLIC™ A2 has been ranked up to class A2 which is one of highest fire-safety grades in accordance with European Norm (EN) standard.



WORKABILITY:

Easy to process with ordinary fabrication machines and tools



ECOLOGY:

Recyclable and environmentally friendly



Production

ALPOLIC™ is produced in Japan, United States and Germany. In our production plants, we collect both aluminum, other metals and the core material for recycling by means of our original system, to keep an eco-friendly operation. Furthermore, our production plants are ISO 9001/14001 compliant, and also designated as wide district industrial waste disposal facilities. Therefore, we can take back scraps from customers for recycling in compliance with the proper operating standards.

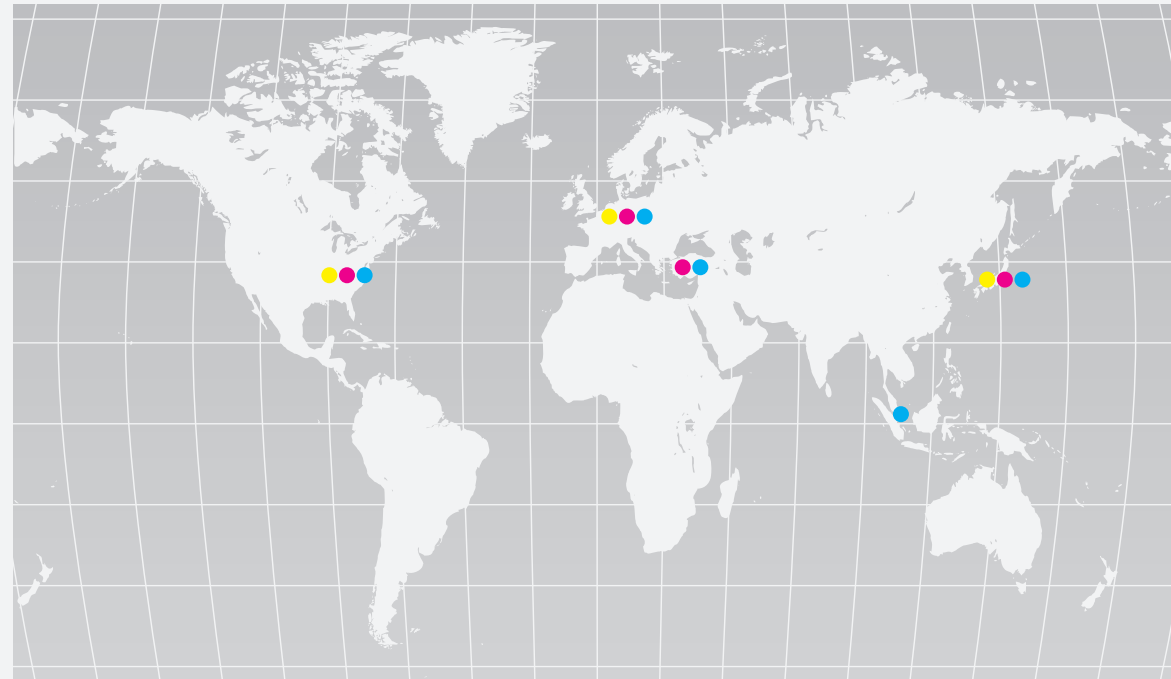

- ALPOLIC™ production plants : Japan 2, USA 1, Germany 1
- ALPOLIC™ Stock Points : Japan, USA, Germany, Turkey
- ALPOLIC™ sales or branch offices : Japan, Singapore, USA, Germany, Turkey



Recycling process

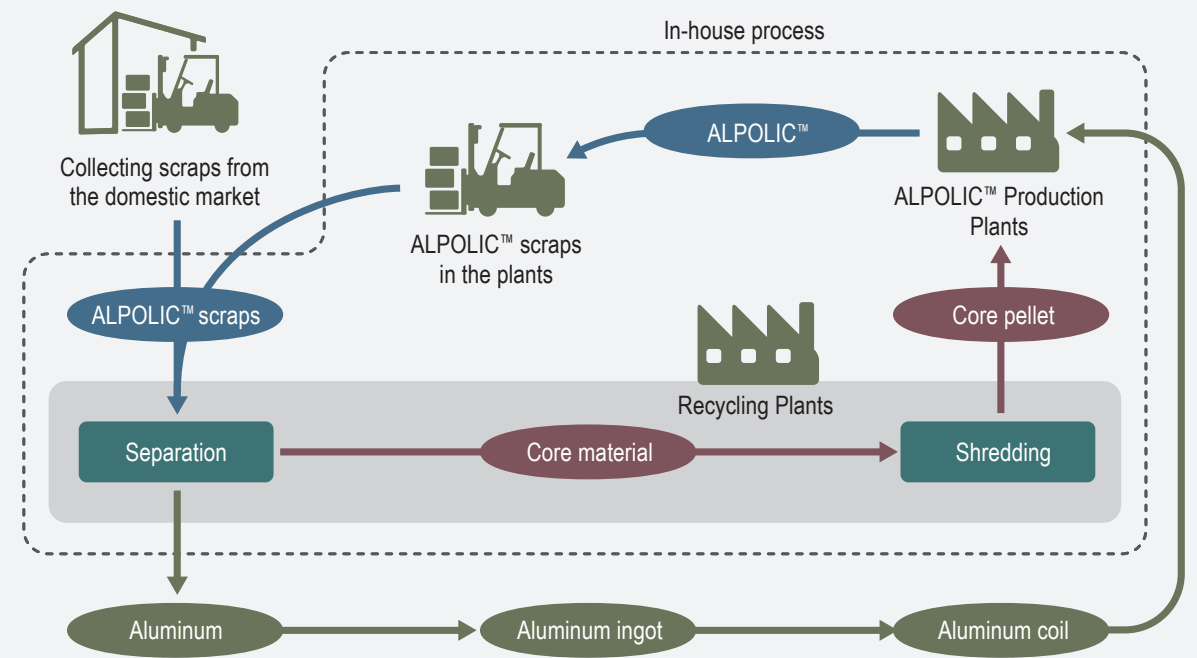



ALPOLIC™ A2 | P07

Superior fire-retardant ACM / In compliance with Euroclass A2

Istanbul Marriott Hotel Sisli / Turkey

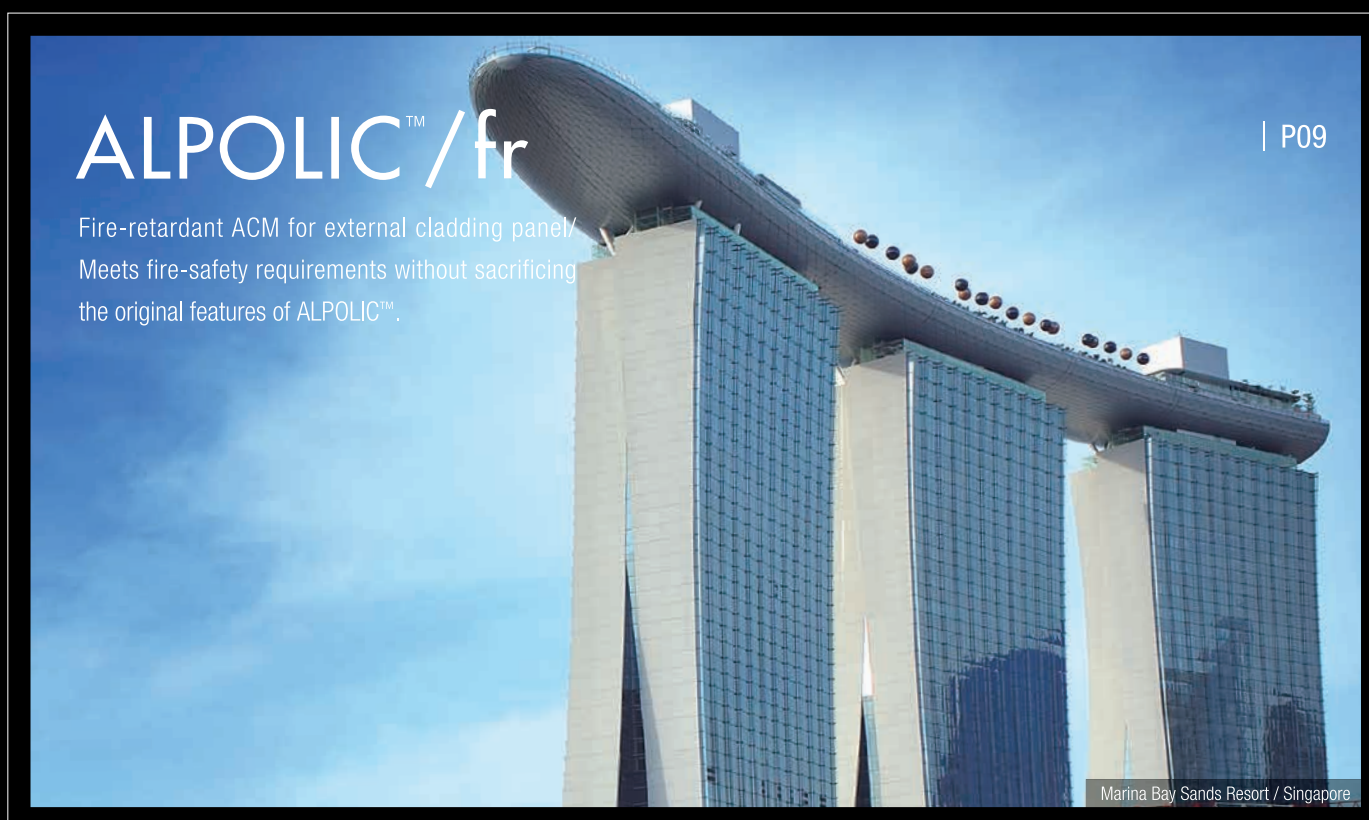

ALPOLIC™ /fr | P09

Fire-retardant ACM for external cladding panels / Meets fire-safety requirements without sacrificing the original features of ALPOLIC™.

Marina Bay Sands Resort / Singapore



ALPOLIC™ /fr TCM | P13

Titanium Composite Material / High corrosion resistance



ALPOLIC™ /fr SCM | P15

Stainless Steel Composite Material / High rust resistance



ALPOLIC™ /fr CCM | P17

Copper Composite Material / For richness and depth to any building's facade

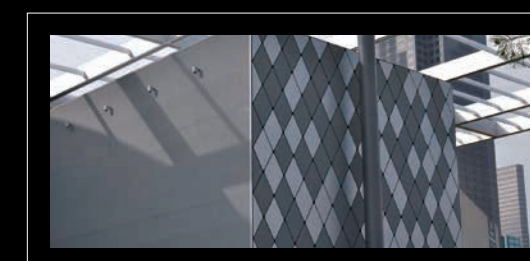

ALPOLIC™ /fr ZCM | P18

Zinc Composite Material / For elaborate designs



ALPOLIC™ /fr LT | P21

Perfect for interior applications with a non-combustible mineral-filled core

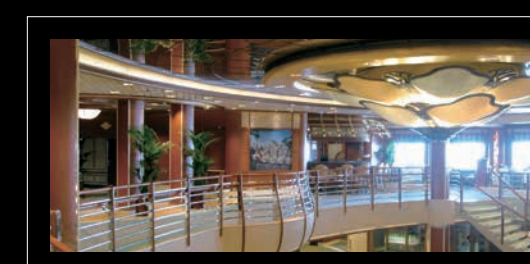

ALPOLIC™ /fr RF | P22

Second generation mirror finish ALPOLIC™



ALPOLIC™ A2

ALPOLIC™ A2 is an aluminum composite material (ACM) with a high fire-retardant core, used as exterior and interior claddings and roof coverings in new building and retrofit applications. ALPOLIC™ A2 has been classified as having a superior fire-safety grade to various other types of ACM.

90%

ALPOLIC™/A2 consists of approx. 90% of non-combustible ingredients within the core material.

Composition of ALPOLIC™ A2

Total thickness : 4mm

Fluoropolymer coating

Aluminium 0.5mm

Rust Preventing Paint

Non-combustible high mineral filled core

Service coating

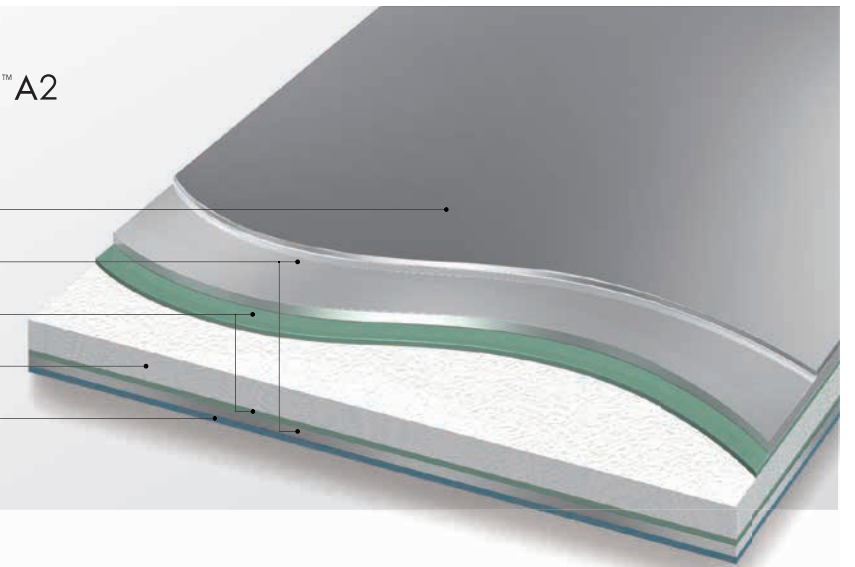

DIMENSION (STANDARD)

Thickness (tolerance ±0.2mm)	Standard Width (tolerance; ±2.0mm)	(Bow tolerance)
4mm	1270,1575mm	±0.5% of the length and/or width
Skin thickness	Length (tolerance; ±4.0mm)	(Squareness tolerance)
0.5mm	1800-7200mm	Max 5.0mm

FIRE PERFORMANCE OF ACM SERIES

Core Material	ALPOLIC™ PE	ALPOLIC™ /fr	ALPOLIC™ A2
Approx. portion of combustible ingredients within the core material	100%	< 30%	< 10%
Heat Potential of the core material	> 45 MJ/kg	< 13 MJ/kg	< 3 MJ/kg
Reference Fire Classification	Euroclass C - D (EN 13501-01:2007)	Euroclass B (EN 13501-01:2007)	Euroclass A2 (EN 13501-01:2007)

CHARACTERISTICS (FOR STANDARD DIMENSION)

	Method	Unit	ALPOLIC™ A2	
Physical properties	Thickness	—	4mmt	
	Specific gravity	—	2.03	
	Weight	—	kg/m²	
	Thermal expansion	ASTM D696	×10⁻⁴/°C	19
	Thermal conductivity	Calculated value	W/m-K	0.45
	Deflection temperature	ISO 75-2	°C	110
Mechanical properties of composite material	Tensile strength	ASTM E8	MPa, N/mm²	
	0.2% proof stress	ASTM E8	MPa, N/mm²	
	Elongation	ASTM E8	%	3.8
	Flexural elasticity, E	ASTM C393	GPa, kN/mm²	38.5
Sound Transmission Loss	ASTM E413	STC	27	
Metal thickness with equivalent rigidity	Calculated value		Aluminium 3.3mm	



Busan National Maritime Museum / Korea



Riyadh Techno Valley (RTV) / Saudi Arabia



Dincalis Mall Project / Turkmenistan

ALPOLIC™/fr

ALPOLIC™/fr is a fire-rated ACM composed of aluminum skins and a fire-retardant core (non-combustible mineral-filled core). It passes most countries' fire-safety codes for exteriors and interiors. Compared with solid aluminum panels, ALPOLIC™/fr is lightweight, rigid and flat. The surface finish is a coating of fluorocarbon paint, Die Coater that we use in the continuous coil coating line ensures uniform color and smooth coating. Coating variations includes the Patterns (Stone, Timber, Metal, and Abstract), produced with a unique image-transfer coating.

70%

ALPOLIC™/fr consists of approx. 70% of non-combustible ingredients within the core material.

Composition of ALPOLIC™/fr

Total thickness : 4,6mm

Fluoropolymer coating

Aluminium 0.5mm

Rust Preventing Paint

Non-combustible mineral filled core

Service coating

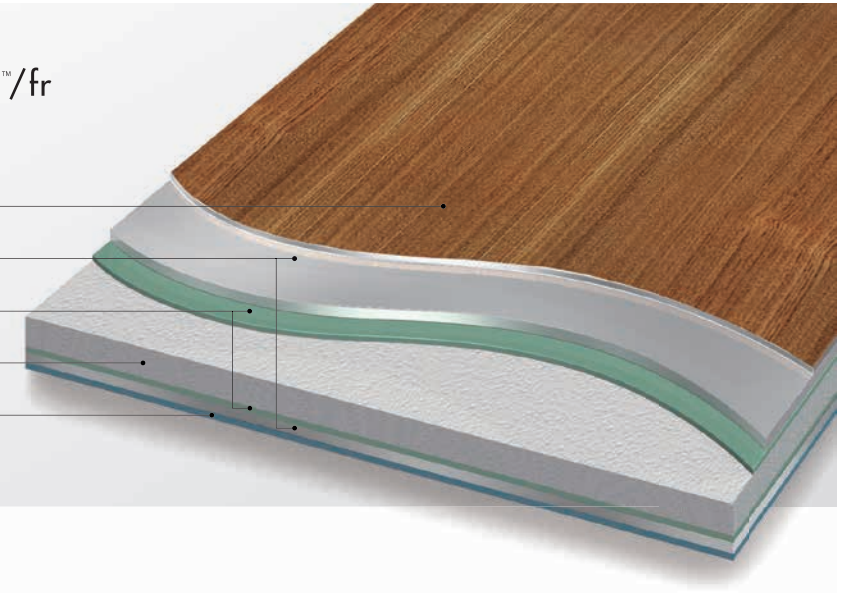

DIMENSION (STANDARD)

Thickness (tolerance ±0.2mm)	Standard Width (tolerance; ±2.0mm)	(Bow tolerance)
4mm	965, 1270, 1575mm	±0.5% of the length and/or width
Skin thickness	Length (tolerance; ±4.0mm)	(Squareness tolerance)
0.5mm	< 7200mm	Max 5.0mm

CHARACTERISTICS (FOR STANDARD DIMENSION)

	Method	Unit	ALPOLIC™/fr
Physical properties	Thickness	-	4mmt
	Specific gravity	-	1.90
	Weight	-	kg/m ²
	Thermal expansion	ASTM D696	×10 ⁻⁴ /°C
	Thermal conductivity	Calculated value	W/m-K
	Deflection temperature	ISO 75-2	°C
Mechanical properties of composite material	Tensile strength	ASTM E8	MPa, N/mm ²
	0.2% proof stress	ASTM E8	MPa, N/mm ²
	Elongation	ASTM E8	%
	Flexural elasticity, E	ASTM C393	GPa, kN/mm ²
Sound Transmission Loss	ASTM E413	STC	27
Metal thickness with equivalent rigidity	Calculated value		Aluminium 3.3mm

Paint System

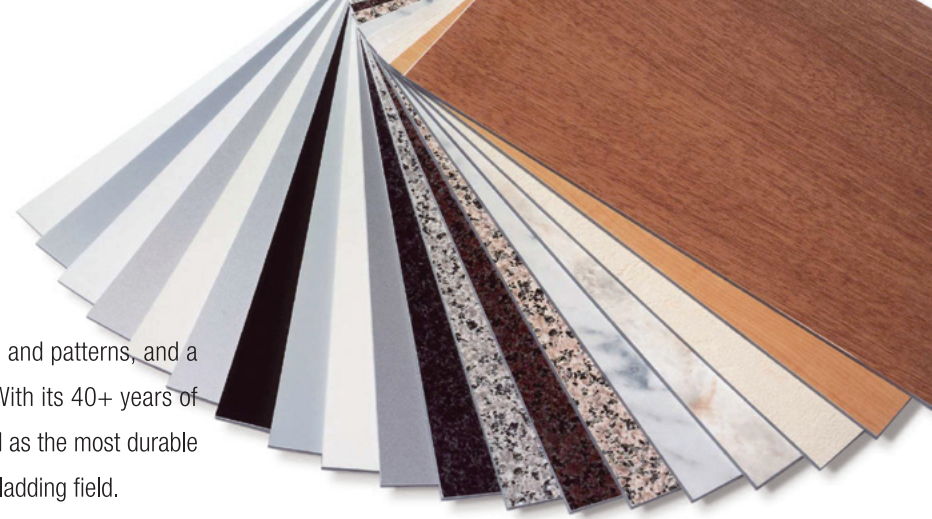

ALPOLIC™ paint coating offers a variety of colors and patterns, and a wide range of gloss effects from 15% to 80%. With its 40+ years of experience, ALPOLIC™ paint coating is recognized as the most durable and reliable paint coating system in the external cladding field.

[Principle]

ALPOLIC™ for external applications is regularly coated on its exposed surface side with a first-class fluorocarbon paint system. The standard coating warranty period is conditionally 20 years. In addition to the regular ISO quality management system, ALPOLIC™ quality control assures the deepest satisfaction to the customer seeking high-end products. We have confidence not only in the high grade of the paint itself, but also in color consistency throughout the production lots. ALPOLIC™ paint coating is usually evaluated with chamber tests such as accelerated weathering, salt spray, etc. It is also checked regularly by means of actual decades-long exposure in harsh coastal climates.



Natural exposure test in Japan & South Florida, USA

[Prêt-à-Porter]

Our standard and semi-standard colors covers most popular finishes used in many buildings over the world in recent decades. ALPOLIC™ standard colors have represented part of tradition in modern architectural buildings. ALPOLIC™ paint coating has proved its long-lasting durability and overwhelming presence throughout the history of external cladding applications.

[Haute Couture]

ALPOLIC™ Paint Coating provides unlimited styles to the building designer. Tailor-made colors are our outstanding technology that highlight an architect's personality. We are ready to provide maximum service upon choosing among the widest range of colors, gloss, and patterns available and withstands to external cladding.

Fire Performance

The core material between the metal skins plays main role of the fire performance of composite materials. ALPOLIC™/fr and ALPOLIC™ A2 are exclusively designed in order to meet most of all the fire regulations over the world without any limitations to the building cladding applications. Without losing original properties of ALPOLIC™, such as flatness, strength, durability, and easy processing etc, Mitsubishi Chemical Infracore pursues total balance of the panel at the same time it achieves the best performance on the fire safety.



	ALPOLIC™ PE	ALPOLIC™/fr	ALPOLIC™ A2
Thickness	4mm	4mm	4mm
Approx. portion of combustible ingredients within the core material	100%	< 30%	< 10%
Heat Potential of the core material	> 45 MJ/kg	< 13 MJ/kg	< 3 MJ/kg
Europe	BS 476 Part 6 (Class 0) BS 476 Part 7 (Class 1) DIN 4102 Part 1 (B2)	EN 13501-1 (B-s1-d0)	EN 13501-1 (A2-s1-d0)
USA	ASTM E84 (Passed class 1/A)	ASTM E84 (class 1/A) ASTM E108 ASTM E108 Modified UBC 26-9 & NFPA 285 ASTM E119 UBC 26-3 (Passed)	
Canada		CAN/ULC-S 134-92 (Passed)	
Russia		GOST (G1,B1,T1,D1,K0)	GOST (G1,B1,T1,D1,K0)
Japan		Passed. Certified as non-combustible material	

	Polyethylene	Aluminium Hydroxide
Chemical Reaction	$(-CH_2-) + O_2 \rightarrow CO_2 + H_2O$	$2Al(OH)_3 \rightarrow Al_2O_3 + 3H_2O$
Status	Heat Generation	Heat Absorption

	Melting Point
Titanium	1668°C
Stainless Steel	1424°C
Copper	1084°C
Aluminium	660°C
Zinc	420°C





Taipei Arena / Taiwan



Hangzhou Grand Theater / China

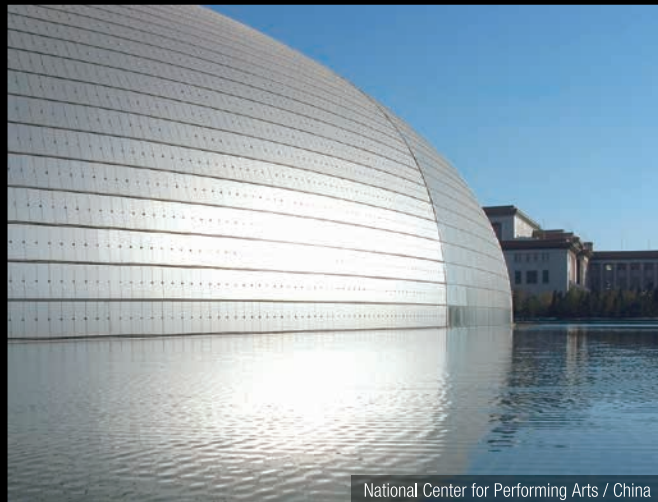

National Center for Performing Arts / China

ALPOLIC™/fr TCM

ALPOLIC™/fr TCM is a titanium composite panel composed of a 0.3 mm thick titanium sheet on the topside, a non-combustible mineral-filled core and 0.3 mm thickness stainless steel sheet on the backside. Titanium metal quickly forms a stable oxide film (called "passivated film") at room temperature and is known for its unparalleled corrosion resistance. ALPOLIC™/fr TCM is suited to the external claddings and roof coverings of buildings located in highly corrosive environments.

99.5% Titanium, the top surface metal skin of TCM, contains approx. 99.5% of pure-titanium.

Composition of ALPOLIC™/fr TCM

Total thickness : 4mm

Dull finish

Topside Titanium 0.3mm
Backside Stainless steel 0.3mm

Non-combustible mineral filled core

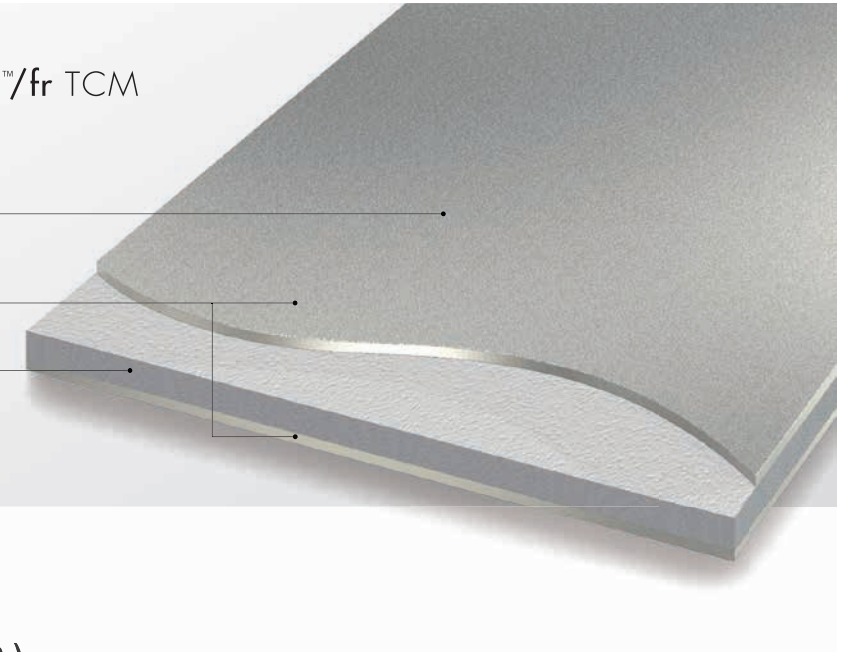

DIMENSION (STANDARD)

Thickness (tolerance ±0.2mm)	Standard Width (tolerance; ±2.0mm)	(Bow tolerance)
4mm	1000 (1219mm is available upon request)	±0.5% of the length and/or width
Skin thickness	Length (tolerance; ±4.0mm)	(Squareness tolerance)
0.3mm	<5000mm	Max 5.0mm

CHARACTERISTICS (FOR STANDARD DIMENSION)

	Method	Unit	ALPOLIC™/fr TCM	
Physical properties	Thickness	-	4mmt	
	Specific gravity	-	2.33	
	Weight	-	9.3 kg/m ²	
	Thermal expansion	ASTM D696	×10 ⁻⁴ /°C	10.4
	Thermal conductivity	Calculated value	W/m-K	0.4
	Deflection temperature	ISO 75-2	°C	112
Mechanical properties of composite material	Tensile strength	ASTM E8	MPa, N/mm ²	69
	0.2% proof stress	ASTM E8	MPa, N/mm ²	60
	Elongation	ASTM E8	%	11.1
	Flexural elasticity, E	ASTM C393	GPa, kN/mm ²	49.0
Sound Transmission Loss	ASTM E413	STC	25	
Metal thickness with equivalent rigidity	Calculated value		Titanium 3.1mm	



Jisan & Beommul Library / Korea



Sutluce Halic convention center / Turkey



Caja Vital Kubxa / Spain

ALPOLIC™/fr SCM

ALPOLIC™/fr SCM is a stainless steel composite panel composed of a non-combustible mineral-filled core and two sheets of 0.3 mm thick stainless steel. Both sides of the stainless steel are NSSC220M, a highly rust-resistant ferritic stainless steel, which has an outstanding rust resistance comparable to stainless steel 316. ALPOLIC™/fr SCM is suitable for the external claddings and roof coverings of buildings.

46%

4 mm thick ALPOLIC™/fr SCM is equivalent to 2.9 mm thick solid stainless steel sheet in terms of bending rigidity but SCM is lighter, about 46% of the solid stainless steel weight.

Composition of ALPOLIC™/fr SCM

Total thickness : 4mm

Hairline or Dull finish

Stainless steel 0.3mm

Rust Preventing Paint

Non-combustible mineral filled core

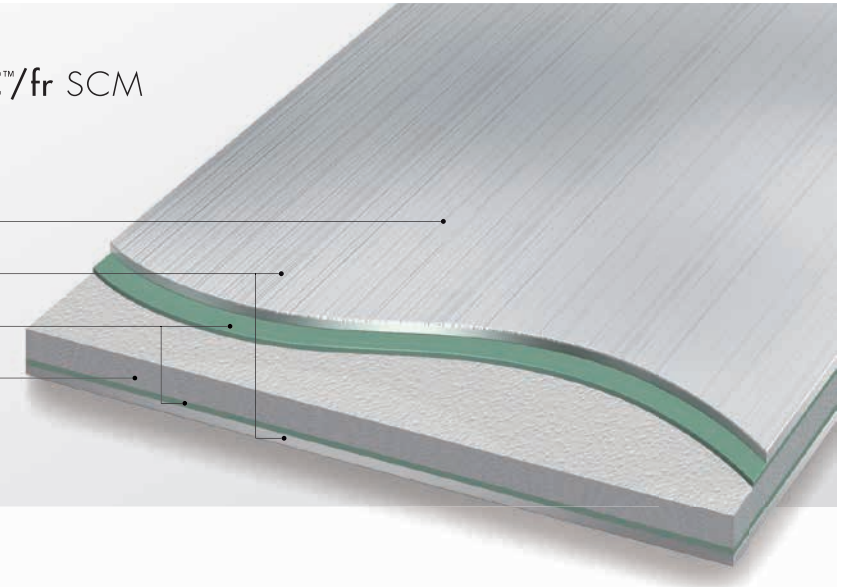

DIMENSION (STANDARD)

Thickness (tolerance ±0.2mm)	Standard Width (tolerance; ±2.0mm)	(Bow tolerance)
4mm	1000(1219mm is available upon request)	±0.5% of the length and/or width
Skin thickness	Length (tolerance; ±4.0mm)	(Squareness tolerance)
0.3mm	<5000mm	Max 5.0mm

CHARACTERISTICS (FOR STANDARD DIMENSION)

	Method	Unit	ALPOLIC™/fr SCM
Physical properties	Thickness	-	4mmt
	Specific gravity	-	2.55
	Weight	-	kg/m ²
	Thermal expansion	ASTM D696	×10 ⁻⁶ /°C
	Thermal conductivity	Calculated value	W/m-K
Mechanical properties of composite material	Deflection temperature	ISO 75-2	°C
	Tensile strength	ASTM E8	MPa, N/mm ²
	0.2% proof stress	ASTM E8	MPa, N/mm ²
	Elongation	ASTM E8	%
Sound Transmission Loss	Flexural elasticity, E	ASTM C393	GPa, kN/mm ²
	Sound Transmission Loss	ASTM E413	STC
Metal thickness with equivalent rigidity	Calculated value		Stainless steel 2.9mm

ALPOLIC™/fr CCM

ALPOLIC™/fr CCM is a copper composite material composed of a copper sheet on the topside, a non-combustible mineral-filled core and a copper sheet on the backside. Like solid copper, ALPOLIC™/fr CCM is perfect for architectural wall cladding applications and accent trim on buildings.



Ceridian Corporate Building / U.S.A

Features

The natural copper surface's ever-changing finish constantly evolves, adding richness and depth to any building's facade. ALPOLIC™/fr CCM offers the rigidity of heavy gauge sheet metal in a lightweight copper-faced composite material. CCM also features such attributes as superior flatness, vibration dampening, durability and ease of maintenance.

ALPOLIC™/fr ZCM

ALPOLIC™/fr ZCM is a zinc composite material composed of a chemically-weathered zinc sheet on the topside, a non-combustible mineral-filled core and a zinc sheet on the backside. ZCM is suited to exterior applications such as soffits, awnings, parapets, rain screens, external claddings and roofs, especially when conventional building materials are insufficient.



University of Western Australia / Australia

Features

Zinc alloy skin: The topside skin is a real zinc alloy weathered with a chemical conversion process, which later takes on a distinctive gray appearance through natural weathering.
Long life: Protected by the surface layers, zinc alloy has a long life. The annual erosion rate is normally 1 to 7 microns (3 microns on average), which indicates that 100 micron (0.1 mm) thick zinc takes as long as 35 years to erode.

Composition of ALPOLIC™/fr CCM

Total thickness : 4mm

Mill finish

Copper sheet 0.4mm

Non-combustible mineral filled core

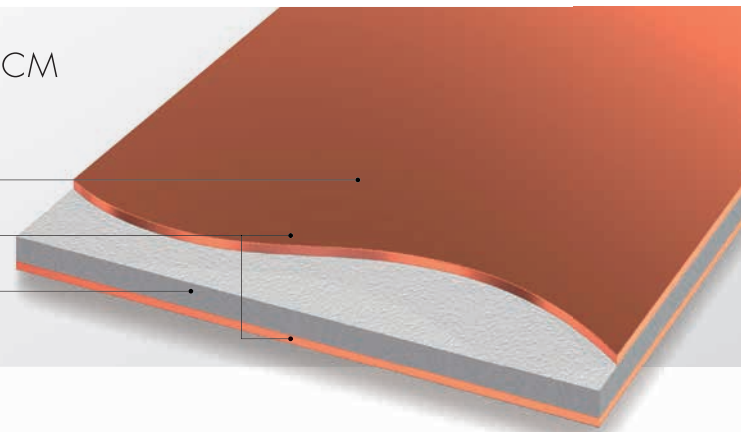

DIMENSION (STANDARD)

Thickness (tolerance ±0.2mm)	Standard Width (tolerance; ±2.0mm)	(Bow tolerance)
4mm	965mm	±0.5% of the length and/or width
Skin thickness	Length (tolerance; ±4.0mm)	(Squareness tolerance)
0.4mm	3708mm	Max 5.0mm

CHARACTERISTICS (FOR STANDARD DIMENSION)

	Method	Unit	ALPOLIC™/fr CCM	
Physical properties	Thickness	-	4mmt	
	Specific gravity	-	3.13	
	Weight	-	12.5 kg/m ²	
	Thermal expansion	ASTM D696	×10 ⁻⁶ /°C	17
	Thermal conductivity	Calculated value	W/m-K	0.42
	Deflection temperature	ISO 75-2	°C	140

Composition of ALPOLIC™/fr ZCM

Total thickness : 4mm

Pre-weathered mill finish

Zinc sheet 0.5mm

Non-combustible mineral filled core

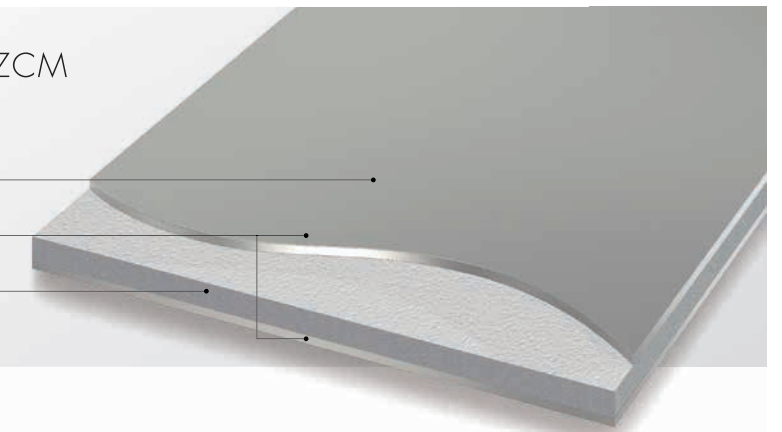

DIMENSION (STANDARD)

Thickness (tolerance ±0.2mm)	Standard Width (tolerance; ±2.0mm)	(Bow tolerance)
4mm	965mm	±0.5% of the length and/or width
Skin thickness	Length (tolerance; ±4.0mm)	(Squareness tolerance)
0.5mm	3708mm	Max 5.0mm

CHARACTERISTICS (FOR STANDARD DIMENSION)

	Method	Unit	ALPOLIC™/fr ZCM	
Physical properties	Thickness	-	4mmt	
	Specific gravity	-	3.13	
	Weight	-	12.5 kg/m ²	
	Thermal expansion	ASTM D696	×10 ⁻⁶ /°C	28(P) / 20(T)
	Thermal conductivity	Calculated value	W/m-K	0.45
	Deflection temperature	ISO 75-2	°C	115

(P); parallel to the rolling direction (T); transverse to the rolling direction

Example of fixing methods

We are introducing typical examples of fixing methods below.
Refer to the ALPOLIC™ Technical Manual, “Section 3 Fabrication & Installation” for the details.

[External wall cladding - wet sealant joint]

This installation system, with tray type (rout and return) panels and sealing joints, is one of the most common methods and it is available for a wide range of new buildings and renovation projects. After fixing ALPOLIC™/fr panels on the substructure, we apply a suitable sealing material to the joints in order to ensure water-tightness.

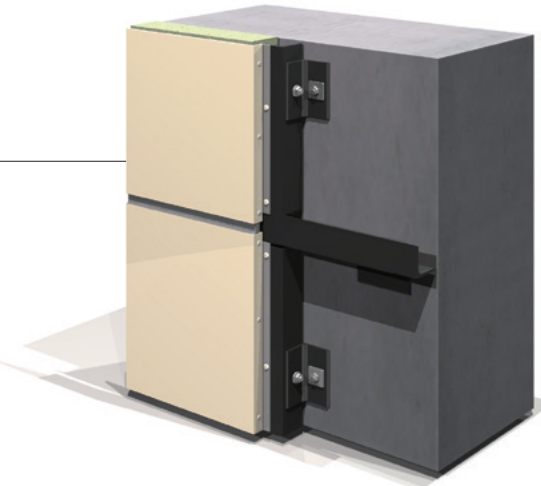

[External wall cladding - hanging method]

The hanging system is also one of the most common fixing methods. It simplifies the installation work at the construction site and hence we can shorten the installation period. It is easy to loosen the movement due to thermal expansion/contraction with this method, because panels are not tightly fastened to the sub-frame but are simply suspended.

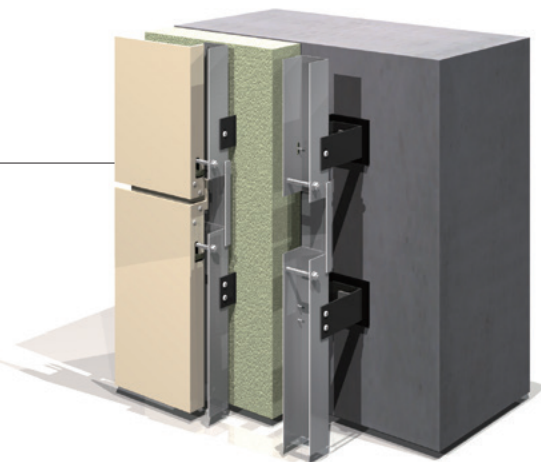

[Curtain wall]

A conventional unitized curtain wall style. ALPOLIC™ is installed on the spandrel part on a curtain wall panel and fixed on aluminum frames by structural silicone sealant, for an example.

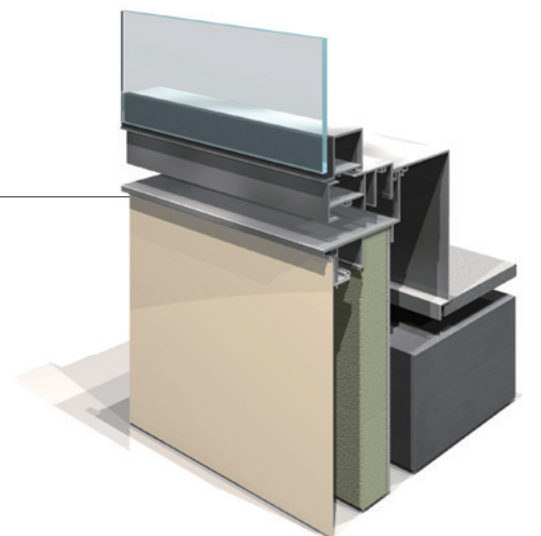

[Roof Covering]

ALPOLIC™/fr has been used for roof covering in prestigious projects such as airports and stadiums. In roof applications, we install a water gutter or waterproof sheets behind ALPOLIC™/fr panels so that leaked water can drain outside.

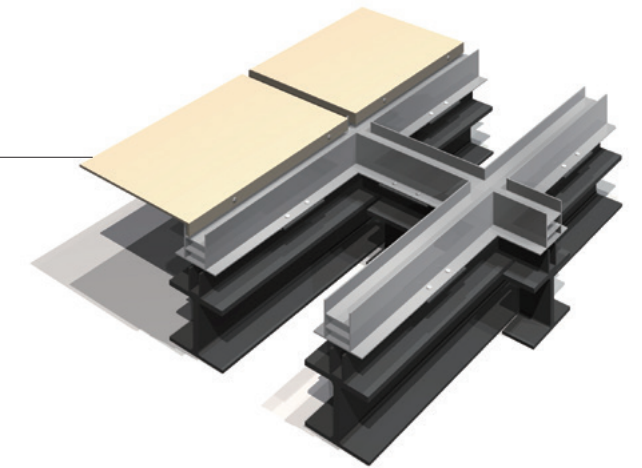

[External wall cladding - hanging method 2]

The other hanging method is suspended by solid aluminum plates with a slot which is fixed on the returned panel edges. It enables to withstand medium to high wind load cases.

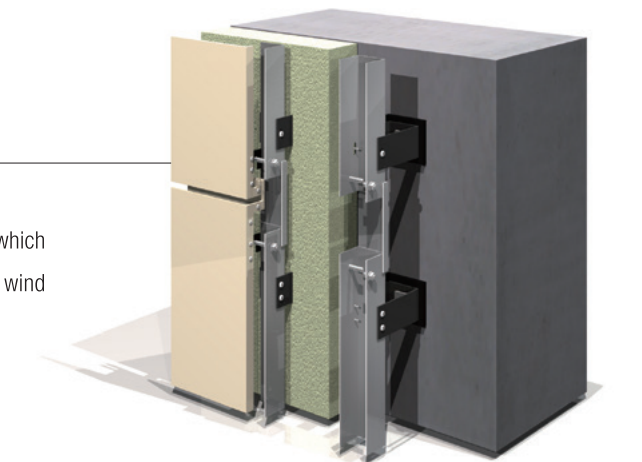

[Back panel of glass curtain wall]

Glass curtain walls sometimes need an opaque spandrel panel (back panel) behind glass for aesthetic and energy-saving purpose. The spandrel back panels behind the glass must be very durable especially to UV exposure, because it is hard to replace them after the building is completed. ALPOLIC™/fr is the perfect material for such applications.

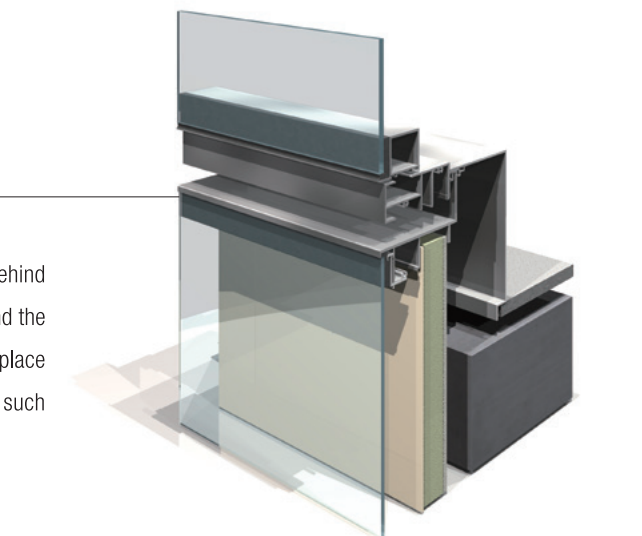

Data embodied herein is intended only for estimate by technically skilled persons, with any use thereof to be at their own discretion and risk. Mitsubishi Chemical Infratec shall have no responsibility or liability for results from such use or infringement of any patent or other proprietary right.

ALPOLIC™/fr LT

ALPOLIC™/fr LT is exclusively designed for interior applications, such as partitions, interior walls, false ceilings etc. It is a fire-rated and safe material, meeting the requirements of UBC 26-3 & ISO 9705 (Interior Room Corner Test) which is an acceptable fire rating in most countries. The main ingredient of the core material prevents the proliferation of flame and restricts the development of smoke which is detrimental to evacuation activities.



The Gallery Bangkok / Thailand

Features
 Easy installation: It can be easily installed on a rigid substrate using a soft set adhesive and or double sided tape.
 Simple processing: It is easily fabricated and formed. Cutting and drilling can be done on site.
 Fire performance: In Japan it has been certified as a non-combustible material (Certificate No. NM-3415)

ALPOLIC™/fr RF

ALPOLIC™/fr RF is a mirror-like reflective finish aluminum composite material (ACM) with a non-combustible mineral-filled core, used as a ceiling or interior wall applications.



Gran Haneda / Japan

Features
 Shatter-proof and safety: Unlike glass, aluminum composite material (ACM) will not shatter or break.
 Easy installation: It can be easily installed on a rigid substrate using a soft set adhesive and or double sided tape.
 Simple processing: It is easily fabricated and formed. Cutting and drilling can be done on site.
 Fire performance: In Japan it has been certified as a non-combustible material (Certificate No. NM-3415)

Composition of ALPOLIC™/fr LT

Total thickness : 3mm

- _____ Polyester coating
- _____ Aluminium 0.3 mm
- _____ Rust Preventing Paint
- _____ Non-combustible mineral filled core
- _____ Service coating

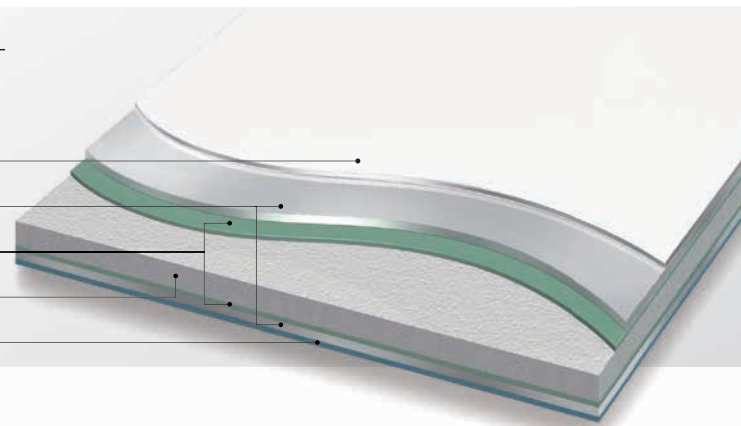

DIMENSION (STANDARD)

Thickness (tolerance ±0.2mm)	Standard Width (tolerance; ±2.0mm)	(Bow tolerance)
3mm	1220mm (Hairline 914mm)	±0.5% of the length and/or width
Skin thickness	Length (tolerance; ±4.0mm)	(Squareness tolerance)
0.3mm	2440mm (Hairline 2438mm)	Max 5.0mm

CHARACTERISTICS (FOR STANDARD DIMENSION)

	Method	Unit	ALPOLIC™/fr LT	
Physical properties	Thickness	-	3 mmt	
	Specific gravity	-	1.83	
	Weight	-	5.5 kg/m ²	
	Thermal expansion	ASTM D696	×10 ⁻² /°C	24
	Thermal conductivity	Calculated value	W/m-K	0.3
	Deflection temperature	ISO 75-2	°C	110

Composition of ALPOLIC™/fr RF

Total thickness : 3mm

- _____ Mirror-look anodized finish
- _____ Aluminium 0.5 mm
- _____ Rust Preventing Paint
- _____ Non-combustible mineral filled core
- _____ Service coating

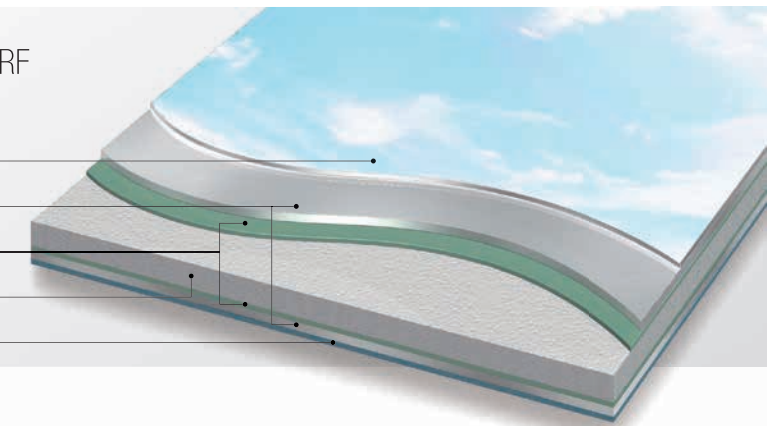

DIMENSION (STANDARD)

Thickness (tolerance ±0.2mm)	Standard Width (tolerance; ±2.0mm)	(Bow tolerance)
3mm	1220mm	±0.5% of the length and/or width
Skin thickness	Length (tolerance; ±4.0mm)	(Squareness tolerance)
0.5mm	2440mm	Max 5.0mm

CHARACTERISTICS (FOR STANDARD DIMENSION)

	Method	Unit	ALPOLIC™/fr RF	
Physical properties	Thickness	-	3mmt	
	Specific gravity	-	2.00	
	Weight	-	6.0 kg/m ²	
	Thermal expansion	ASTM D696	×10 ⁻² /°C	25
	Reflectance	JIS D5705		83%
	Thermal conductivity	Calculated value	W/m-K	0.5

Hidden Rivet Ceiling System + ALPOLIC™

Mitsubishi Chemical Infratec provides ALPOLIC™ sheets with a unique Hidden rivet ceiling system featuring superior flatness and consistent stretch from internal ceilings to external eaves through building entrances or walls. Fixing engineering is supported by Mitsubishi Chemical Infratec upon request to match the application and the design.



Yokohama Immigration Bureau / Japan

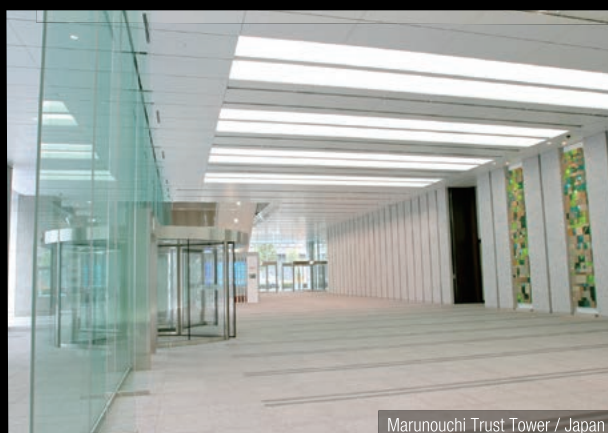

Marunouchi Trust Tower / Japan

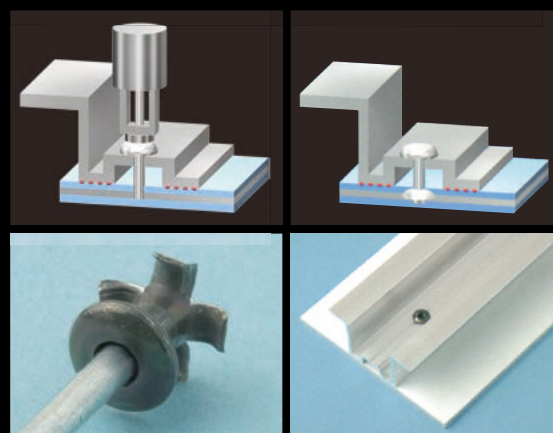

Nagoya Lucent Tower / Japan



Keihan Railway / Nakanoshima station / Japan

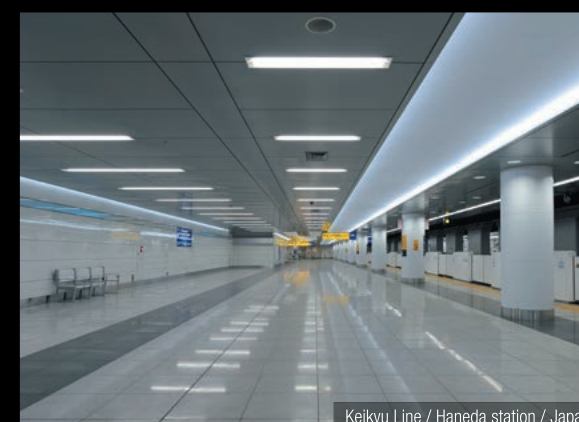

Keikyū Line / Haneda station / Japan



Palace Building / Japan

Processing method

ALPOLIC™/fr and ALPOLIC™ A2 (hereafter, ALPOLIC™) can be processed with regular machines and tools for aluminum and wood. We can cut ALPOLIC™ panels with a circular saw, fold them after grooving and curve them with a 3-roll bender. In order to join aluminum extrusions on ALPOLIC™ panels, we can choose a suitable joining method from several alternatives.

CUTTING

ALPOLIC™ can be cut with various types of circular saws such as table saws, hand circular saws and panel saws. Also, we can use a square shear for cutting, which permits an efficient sizing work. To cut ALPOLIC™ in curving lines, we use hand routers or trimmers.

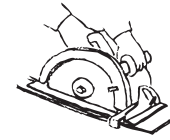

hand circular saw

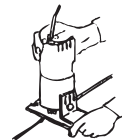

hand trimmer

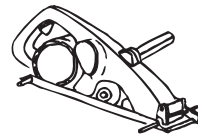

hand groove machine



groove cutter

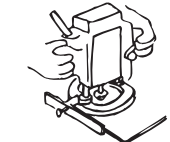

hand router



router bit

U-GROOVING

ALPOLIC™ can be folded after U-grooving in the backside. Two types of machines are available for U-grooving. One is a circular cutter type and the other is a router type. The former includes hand grooving machines and panel saws, and the latter includes hand routers and CNC routers.

FOLDING

After U-grooving, ALPOLIC™ can be folded with a folding jig.

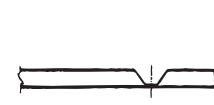

a. U-groove

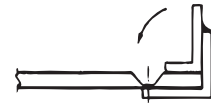

b. use a folding jig

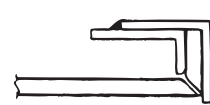

c. fold

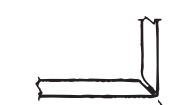

d. check the roundness (2-3mmR)



e. support if necessary

BENDING WITH PRESSBRAKE AND 3-ROLLBENDER

ALPOLIC™ can be bent with a press brake. The bend-ability depends on the thickness and the core material. ALPOLIC™/fr has a larger bendable limit than ALPOLIC™ has. We can also use manual or electric-drive 3-roll benders for curving ALPOLIC™.

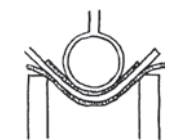

Press brake

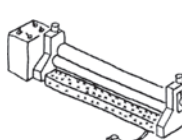

3-roll bender

AUTOMATED MACHINES

In addition to the above conventional machines, we can use automated machines including panel saws and CNC routers for cutting and grooving. These machines enable efficient and precise work, especially suitable for repetition of analogous work.

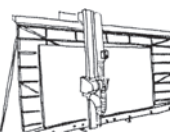

Panel saw

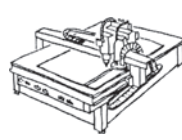

CNC router

JOINING

We often use rivets, bolts/nuts and tapping screws for joining ALPOLIC™ and other materials like aluminum extrusions. In order to prevent from possible galvanic corrosion in a humid atmosphere, use blind rivets made of aluminum. Use screws and bolts/nuts made of aluminum or stainless steel.

General notes

Coating direction

In Metallic Colors, Sparkling Colors, Prismatic Colors and NaturArt Series (Stone, Timber, Metal, and Abstract), slight color differences will be noticeable if the panels are installed in different directions (like Panel A and B in the diagram). Install panels in the same direction as marked in the protective film. In our Solid Colors, any color difference due to coating direction is negligible.

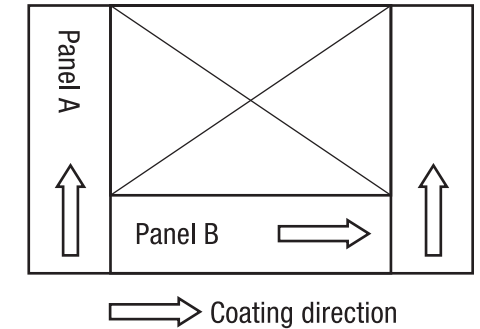

Protective film

The protective film on ALPOLIC™s mostly consists of two polyethylene layers of white and black. Do not peel off the protective film during fabrication and installation to protect the surface from scratching and soiling. Under normal weather conditions, the protective film will withstand 6 (six)-months of outdoor exposure without losing any of its original peel-off characteristics or causing stains or other damage. However, peel off the protective film as soon as possible after completion.

Gloss increase due to plasticizer

Do not stick, put or apply PVC tapes, polyurethane sealant or modified silicone sealant onto our protective film. The plasticizer contained in these materials can permeate the protective film and cause a gloss change in the coating.

Note:

The above precautions pertain to ALPOLIC™/fr and ALPOLIC™ A2. The affiliated products including TCM, SCM, ZCM, CCM, ALPOLIC™/fr LT, and ALPOLIC™/fr-RF have their respective precautions. Refer to the separate brochure of the respective products for details.

ISO 9001:2008 Certified

The production of ALPOLIC™s is ISO 9001:2008 compliant throughout the design, development, manufacture and sales.

ISO 14001:2004 Certified

ALPOLIC™s are produced in plants that have ISO14001:2004 certificate.

 **MITSUBISHI CHEMICAL INFRATEC CO.,LTD.**

Advanced Materials Business Unit
1-1-1, Marunouchi, Chiyoda-ku Tokyo 100-8251, Japan
Phone: +81-(0)3-6748-7348
Fax: +81-(0)3-6685-4905
E-mail: info@alpolic.jp

- The information and data contained in this brochure are as of January, 2022.
- The content of this brochure may be changed without prior notice.
- ALPOLIC is trademark of Mitsubishi Chemical Infratec Co., Ltd.
- Due to printing characteristics, the color tones may differ from the actual ones.
- The transcription of any data or information contained in this brochure without prior written consent is strictly prohibited.

- 本リーフレット記載の内容に含まれる情報・数値は2022年1月時点のものです。
- 本リーフレット記載の内容については予告なく変更する場合があります。
- ALPOLIC®は三菱ケミカルインフラテックの登録商標です。
- 色調については印刷の特性上、現物と異なる場合があります。
- 本カタログからの無断転載を禁じます。

MITSUBISHI POLYESTER FILM GmbH

ALPOLIC Division
Kasteler Strasse 45/E512, 65203 Wiesbaden, Germany
Phone: +49-(0)611-962-3482
Fax: +49-(0)611-962-9059
E-mail: info@alpolic.eu

MITSUBISHI CHEMICAL SINGAPORE PTE. LTD.

ALPOLIC Division
9 Raffles Place, #13-01/02 Republic Plaza,
Singapore 048619
Phone: +65-6226-1597
E-mail: info@alpolic.sg

MITSUBISHI CHEMICAL EURO ASIA LTD.

Altunizade Kisikli Cad., No:14, Akoz Is Merkezi, A Blok,
Kat:3 Daire:8, Uskudar, Istanbul, Turkey
Phone: +90-216-651-8670/71/72
Fax: +90-216-651-8673
E-mail: info@alpolic.com.tr

MITSUBISHI CHEMICAL AMERICA, INC.

ALPOLIC Division
401 Volvo Parkway, Chesapeake, VA 23320, USA
Phone (USA): 800-422-7270
Phone (International): +1-757-382-5750
Fax: +1-757-436-1896
E-mail: info@alpolic.com